

DIMENSIONS

MILLIMETERS(INCHES)

DNV Series Pressure Switches

(No point, sensor pressure switches, high switching capacity)

CAUTION FOR INSTRUCTION, OPERATING CONTROLS AND CONNECTIONS

Rated operating voltage: DC12~24V

Rated operating current: < 1.1 mA (Max 1.1 mA)

Operating controls and connections as figure 1

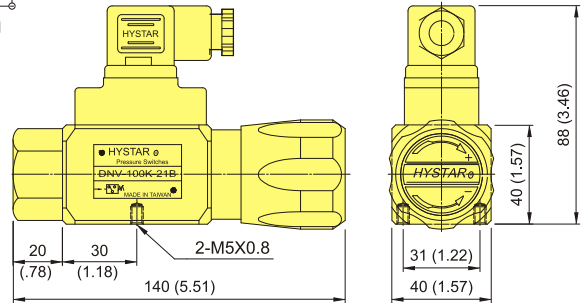
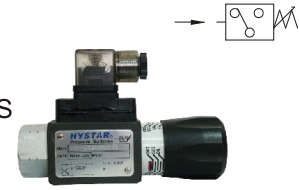
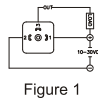
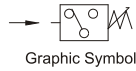
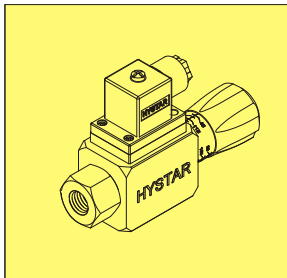

Ordering Code

DNV - 100K - N - 21B

- ① ② ③ ④

- ① Series
DNV-Direct read-out,
Heavy-duty sensor pressure switch.
- ② Pressure Adj. Range

Model	Pres Adj. Range bar	Surge Pres. bar	Weight kg
050K	6~ 50	200	1.0
100K	15~100	300	1.0
200K	30~200	300	1.0
280K	40~280	350	1.0
400K	50~400	450	1.0

- ③ Method of Output
N: NPN-(standard)
P: PNP
- ④ Design Number
21B:1/4"PT(Rc)
21B80:1/4"PF(G)
21B90:1/4"NPT

Hysteresis Diagrammes

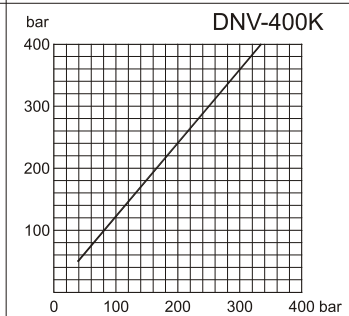
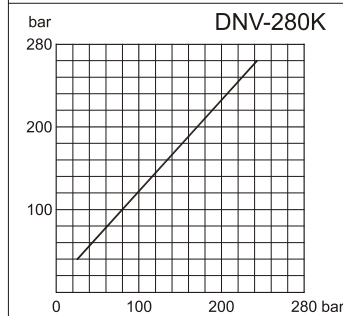
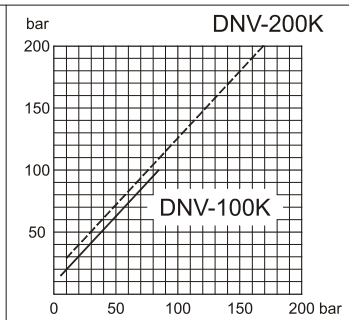
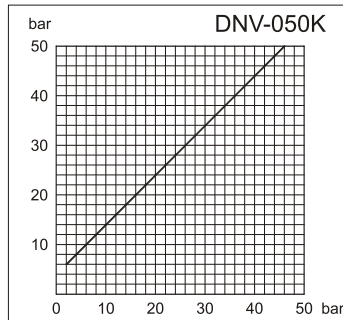

Schematic Cross-Section

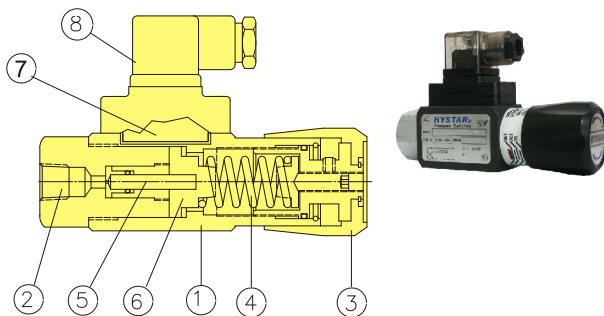

No.	Part Name
1	Body(Casting-Iron)
2	Connection Port 1/4"PT(Rc)
3	Pressure Adj. Knob
4	Spring
5	Servo-Piston
6	Sensor Point
7	Sensor Switches
8	Electrical Connector